



MUTUALMATERIALS®
BUILDING BEAUTY THAT LASTS

HARDSCAPE & MASONRY

PRODUCT SELECTION GUIDE

PAVERS | RETAINING WALLS | ARCHITECTURAL SLABS | BRICK

At Mutual Materials, we are proud of what we do and are inspired to see our products chosen by professionals to build communities. Our products build beauty that lasts through hospitals, schools, stadiums, businesses, family homes, public parks, and backyards. Mutual Materials has long served a professional network of architects, interior designers, builders, masons, and landscape design professionals. Today we also serve residential homeowners, both through our professional networks and through our retail branch locations.



Kendall Anderegg
President, Mutual Materials

A Message from our President

The story of Mutual Materials began over 120 years ago with an innovative brick mason from California who came to Seattle to join the rebuilding effort after The Great Seattle Fire of 1889. Since then, we have grown into the largest family-owned masonry and hardscape products manufacturer in the Pacific Northwest. We are proud of the contribution our company and products have made in building the communities we live in, from our local sports stadiums and neighborhood schools to homes, and beautifully landscaped backyards. Our mission of building beauty that lasts means that the products and materials we use to build schools, stadiums, commercial buildings, and family homes and gardens will last for future generations to enjoy.

Our commitment to our customers has not changed as we have grown and expanded over the years. Right Product, Right Place, Right Time – getting you the products you need, where you need them and at the right time – is the promise that Mutual Materials’ entire team is dedicated to meeting every day.

On behalf of all of us at Mutual Materials, I want to thank you for continuing to consider making our products part of your homes and communities. We know that our customers are the reason we are in business and whether you shop online or at one of our branches, we appreciate you.

Sincerely,

A handwritten signature in black ink that reads "Kendall Anderegg".



Summit Blend StackStone Retaining Wall with Onyx Coping, Cascade Blend RomanStack Fire Pit, Charcoal 24 x 24 Glacier Slate Slabs & Mountain Blend Brick Wall



PAVERS

Clay Pavers.....	4	Holland Pavers.....	6	Uni Ecoloc®.....	7
Dominion Slate and Dominion.....	5	Plank Pavers.....	7	TurfStone.....	7
Roman Cobblestone.....	5	Permeable Holland Herringbone.....	7	Product Data: Pavers.....	11-12
Old Dominion Squares & Recs.....	6	Eco-Priora®.....	7	Product Data: Slabs.....	13
Old Dominion Circle Kits.....	6	Uni Eco-Stone®.....	7	Paver & Slab Patterns.....	14-15



SLABS

Vancouver Bay Architectural Slabs.....	8	Columbia Patio Series.....	10	Product Data: Slabs.....	13
Porcelain Architectural Slabs.....	9	Slaton™.....	10	Paver & Slab Patterns.....	14-15
Glacier Slate Architectural Slabs.....	9	Product Data: Pavers.....	11-12		



RETAINING WALLS

MagnumStone®.....	16-17	ManorStone® Elite.....	20	StackStone®.....	22
CornerStone®.....	18	CypressStone™.....	21	TuscanStone™.....	22
ManorStone®.....	19	Roman Cypress™.....	21	Product Data: Retaining Walls.....	23-25



MASONRY

Face Brick Stocking Colors.....	26-27	Cultured Stone®.....	30-32	Edward's Stone.....	39
SLIMBRICK® Craftsman.....	28	Eldorado Stone.....	33-34		
SLIMBRICK® Glazed.....	29	Natural Stone.....	36-38		

CLAY PAVERS



Roman Clay Pavers

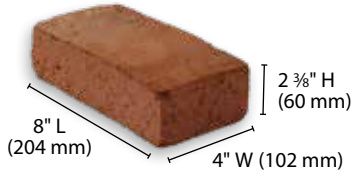

Inca



Mauna Loa



Pioneer Used



Roman Clay Pavers

Patio Pavers

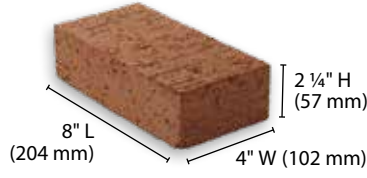

Red Clay

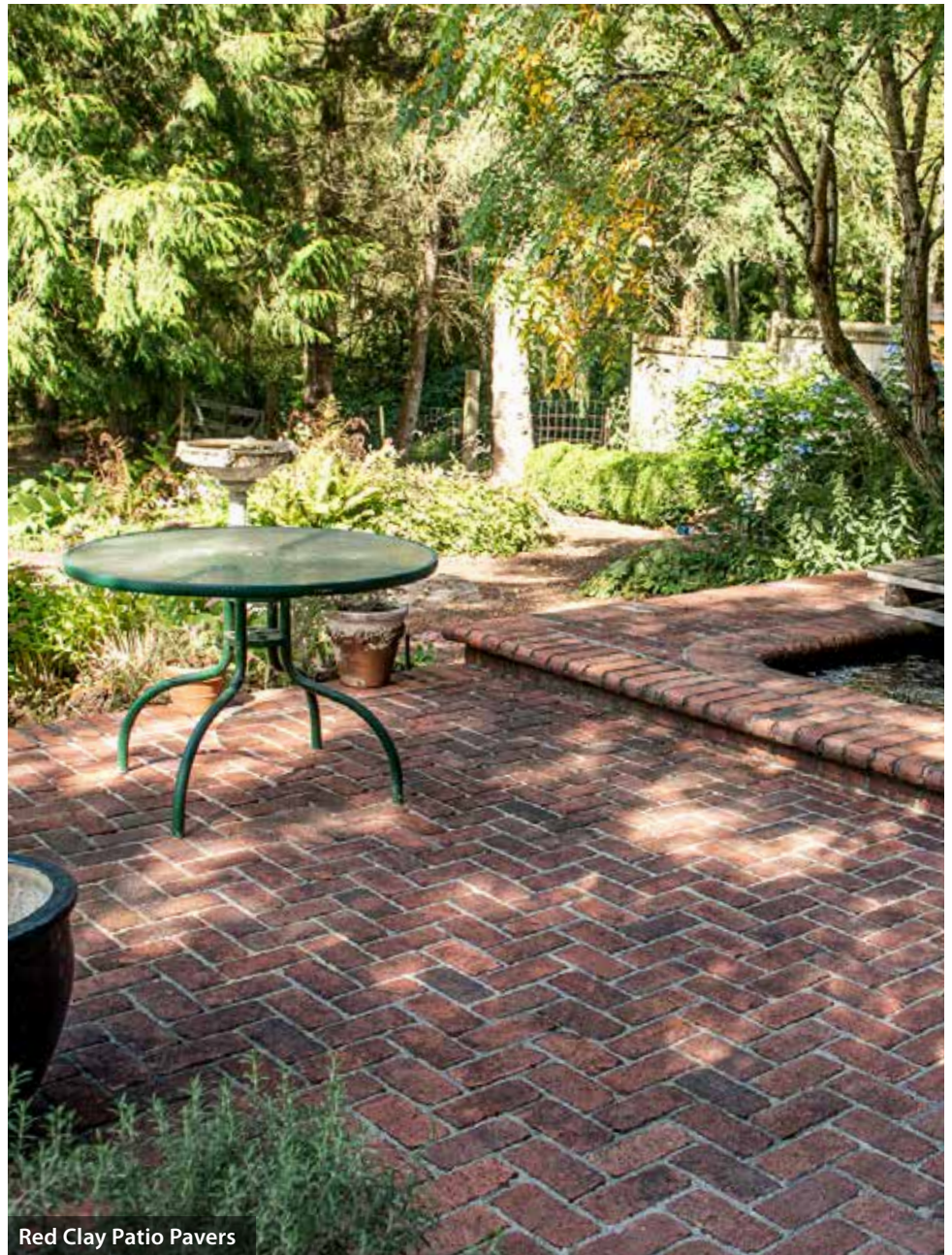

Red Clay Patio Pavers

DOMINION SLATE



Square



Rectangle



Large Rectangle

Not recommended for vehicular use.



DOMINION



Square

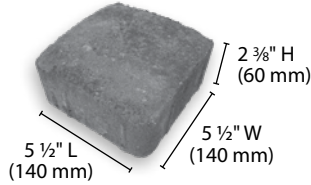

Rectangle

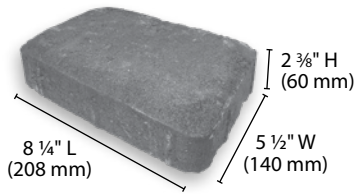

Large Rectangle

Not recommended for vehicular use.

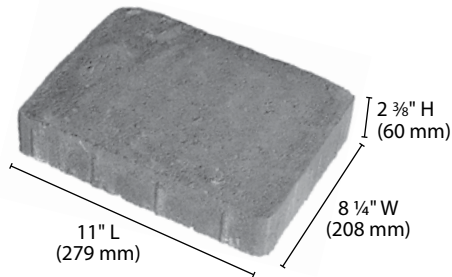

ROMAN COBBLESTONE



Large

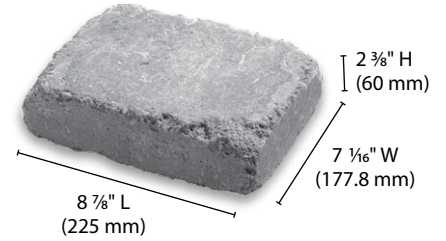

Charcoal



Northwest Blend



Summit Blend



Cascade Blend



Cascade Blend



Northwest Blend



Summit Blend



Charcoal

OLD DOMINION SQUARES & RECS PLUS CIRCLE KITS



Small Rectangle

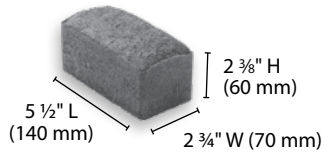

Rectangle

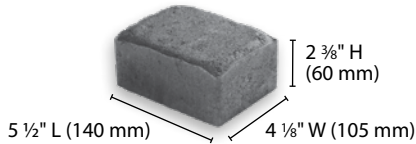

Square

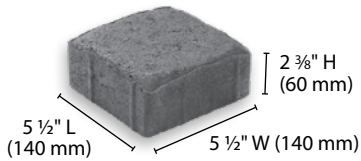

Cascade Blend



Summit Blend

Old Dominion Circle
in Cascade Blend

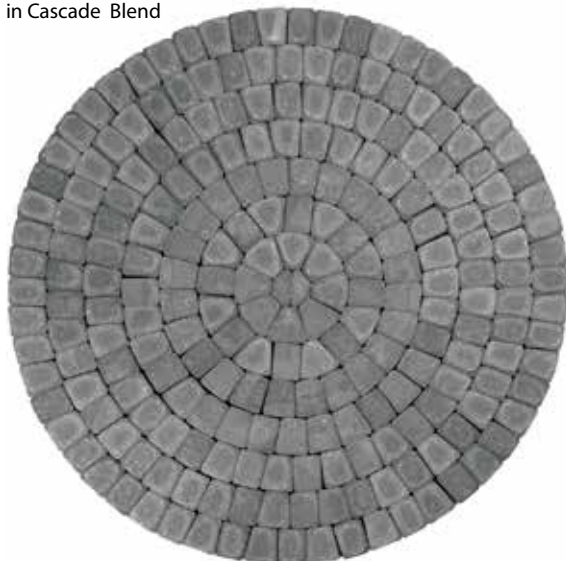

Single Circle Kit
6.96 ft.

Two Circle Kits
9.75 ft.

Center

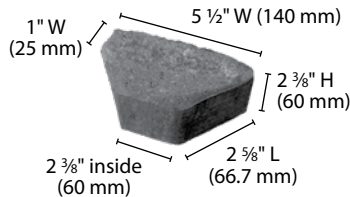

Rectangle

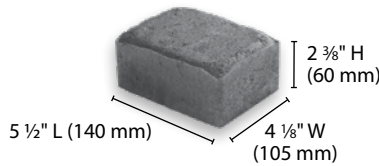

Small Radius

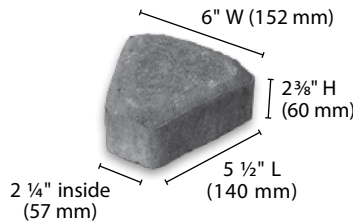

Large Radius

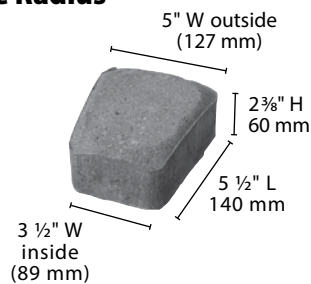

HOLLAND PAVERS



Holland

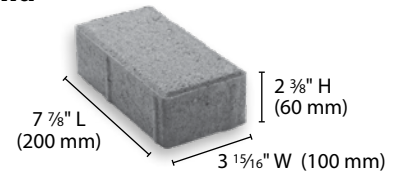

Double Holland

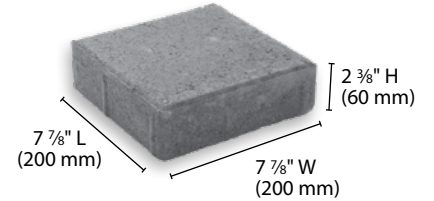

Triple Holland

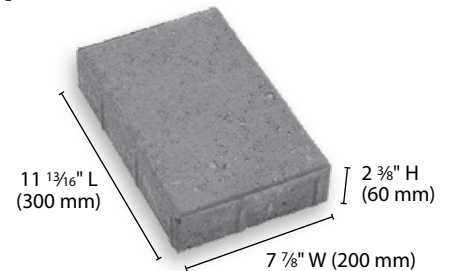

Cascade Blend



Northwest Blend



Onyx



Summit Blend



Rustic Blend (available in 4x8 Holland only)

PLANK PAVERS



PATIOS



WALKWAYS

Plank Paver

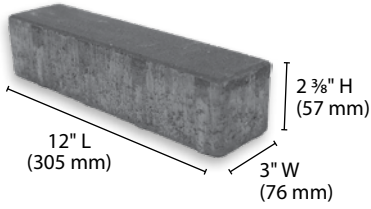

Charcoal

PERMEABLE HOLLAND



DRIVEWAYS



PATIOS



STREETS



WALKWAYS

Permeable Holland Unit

This product is for commercial use only.

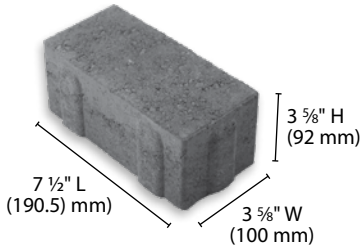

Turfstone

ECO-PRIORA®



DRIVEWAYS



PATIOS



STREETS



WALKWAYS

8 x 8 Unit

There is a 9% void area per square foot.

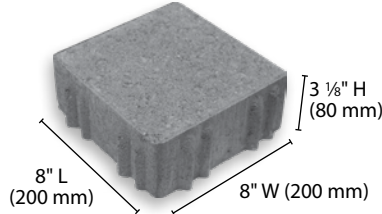

4 x 8 Unit

There is a 13% void area per square foot.

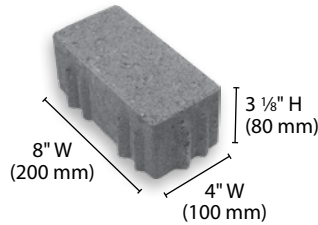

Charcoal



Gray

UNI ECO-STONE®



DRIVEWAYS



PATIOS



STREETS



WALKWAYS

Uni Eco-Stone Unit

There is a 12.8% void area per square foot.
This product is for commercial use only.

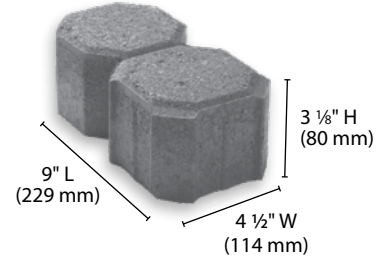

UNI ECOLOC®



DRIVEWAYS



PATIOS



STREETS



WALKWAYS

Uni Ecoloc Unit

This product is for commercial use only.
(There is a 12.8% void area per square foot.)

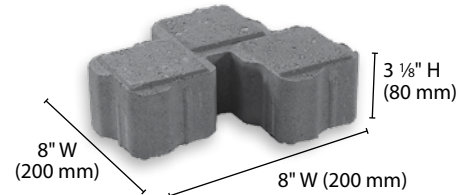

Gray

TURFSTONE®



DRIVEWAYS



WALKWAYS

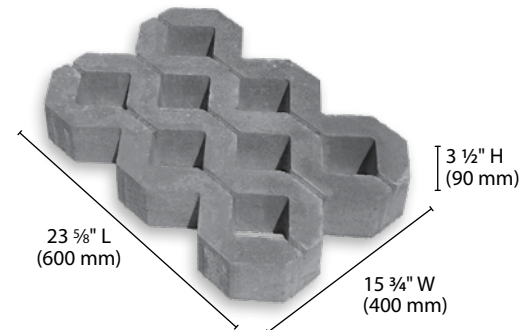

VANCOUVER BAY ARCHITECTURAL SLABS



PATIOS



PLAZAS



WALKWAYS

Vancouver Bay Slabs are not suitable for vehicular traffic.

18 x 18

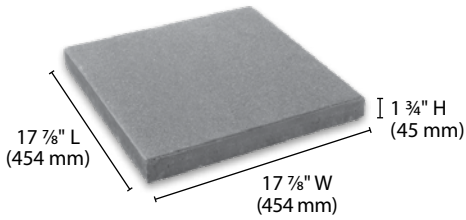

Graphite

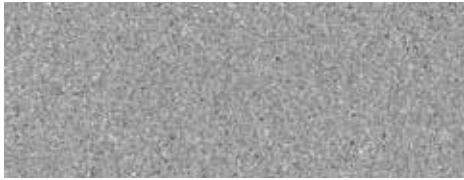

Platinum



Latte

12 x 24

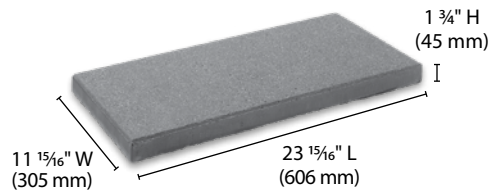

Charcoal

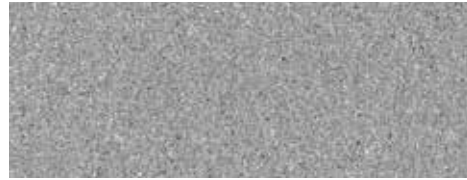

Gray



Latte

24 x 24

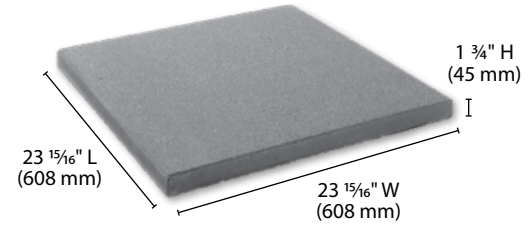

Charcoal

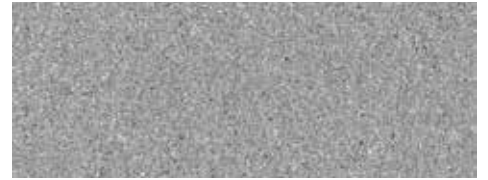

Gray



Latte



12 x 24 Vancouver Bay, Gray and Charcoal

PORCELAIN ARCHITECTURAL SLABS



PATIOS



PLAZAS



WALKWAYS

Porcelain Architectural Slabs are not suitable for vehicular traffic. Slabs must have 4mm spacer to prevent slabs from touching each other (and potentially chipping) and to allow better drainage.

24 x 24

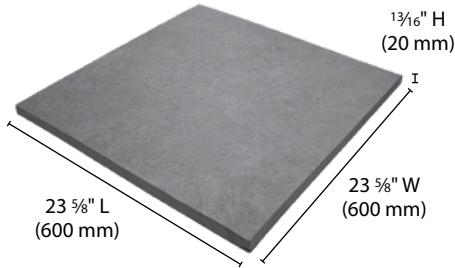

12 x 24

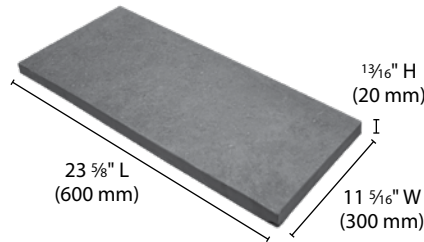

GLACIER SLATE



PATIOS



PLAZAS



WALKWAYS

Glacier Slate Slabs are not suitable for vehicular traffic.

Glacier Slate Unit

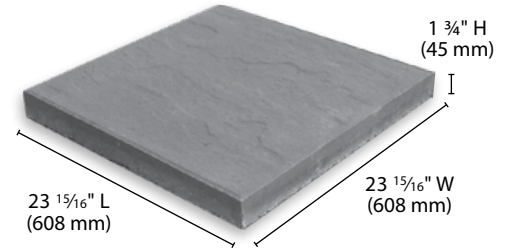

Only sold in 24 x 24.



Limestone



Limestone



Charcoal



Absolute (not available in all branches)



Simply Gray



Black Diamond



Silver Quartz (not available in all branches)



Vintage



Gray



Pepper



Porcelain Architectural Slabs, Simply Gray



Latte



Simply Gray



Glacier Slate, Charcoal



Bluestone Select



Vintage

COLUMBIA PATIO SERIES



PATIOS



WALKWAYS

Columbia Patio Series is not suitable for vehicular traffic.

Rectangle (Slate texture)

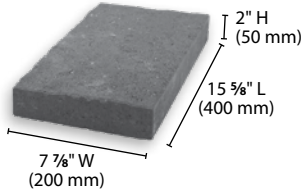

Square (Slate texture)

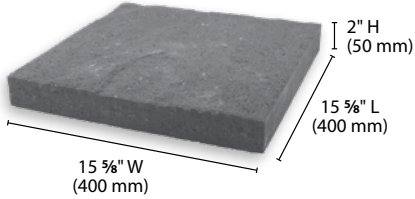

Large Rectangle (Slate texture)

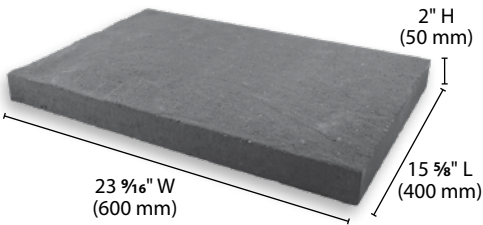

Rectangle (Smooth texture)

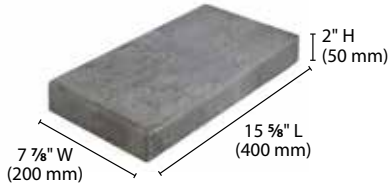

Square (Smooth texture)

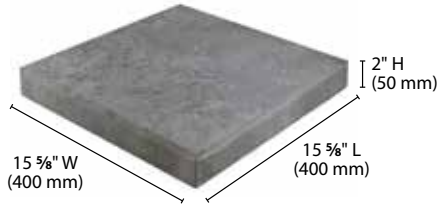

Large Rectangle (Smooth texture)



Cascade Blend



Summit Blend



Northwest Blend



Cascade Blend



Summit Blend



Northwest Blend

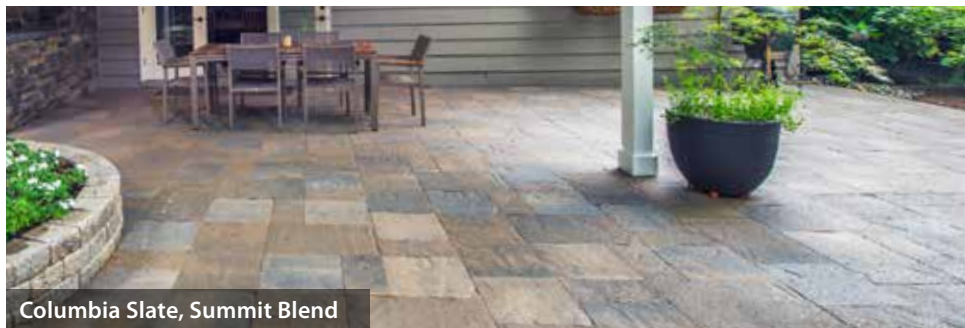

Columbia Slate, Summit Blend

SLATON™



PATIOS



WALKWAYS

Six Face Options



Charcoal



Northwest Blend

PRODUCT DATA: PAVERS

All metric dimensions are soft converted to Imperial. Dimensions and coverage include 1/2" (12.7 mm) joint. All weight per pallet includes a 50 lb pallet weight.

Clay Pavers

	Coverage	Units / Pallet	Coverage / Pallet	Weight / Piece	Weight / Pallet	Use
2 1/4" Paver	4.5 / ft ² (48.44 / m ²)	576	128 ft ² (11.89 m ²)	5.5 lb (2.49 kg)	3,218 lb (1,459.66 kg)	*
2 3/8" Paver	4.5 / ft ² (48.44 / m ²)	576	128 ft ² (11.89 m ²)	6 lb (2.72 kg)	3,506 lb (1,590.29 kg)	*

* Designed to be sand-set. May be used for pedestrian and light vehicular applications.

Dominion Slate and Dominion

	Coverage	Units / Pallet	Coverage / Pallet	Weight / Layer	Weight / Pallet
Square	4.73 pcs / ft ² (51.5 pcs / m ²)	432	91.26 ft ² (8.48 m ²)	5.8 lb (2.6 kg)	2,560 lb (1,161.2 kg)
Rectangle	3.16 pcs / ft ² (34.4 pcs / m ²)	324	102.6 ft ² (9.53 m ²)	8.7 lb (3.9 kg)	2,870 lb (1,302 kg)
Large Rectangle**	1.59 pcs / ft ² (17.1 pcs / m ²)	144	90.8 ft ² (8.43 m ²)	17.6 lb (8 kg)	2,582 lb (1,171.2 kg)

**Large Rectangle not meant for vehicular applications.

Roman Cobblestone

	Coverage	Units / Pallet	Coverage / Pallet	Weight / Unit	Weight / Pallet
Large	2.29 pcs / ft ² (24.45 m ²)	225	97.1 ft ² (9 m ²)	13 lb (5.7 kg)	2,840 lb (1,288 kg)

Old Dominion Squares & Recs

	Coverage Layer	Layers / Pallet	Coverage / Pallet	Weight / Layer	Weight / Pallet
Squares & Recs	11.43 ft ² (1.06 m ²)	9	102.74 ft ² (9.54 m ²)	320 lb (145 kg)	2,930 lb (1,329 kg)

Squares & Rectangles Purchase Requirement

All three (3) shapes are mixed on each layer and must be purchased by the full layer or full pallet.

Squares & Rectangles Pallet Layout

Old Dominion Squares & Rectangles can be installed in a number of random or linear patterns. Experiment until you achieve the look that you desire. The diagram to the right shows the layout of each layer on the pallet.



Square

2 3/8" x 5 1/2" x 5 1/2"
(60 mm x 140 mm x 140 mm)



SQ = Square
(5 1/2" x 5 1/2")



Large Rectangle

2 3/8" x 5 1/2" x 4 1/8"
(60 mm x 140 mm x 105 mm)



LR = Large Rectangle
(5 1/2" x 4 1/8")



Small Rectangle

2 3/8" x 5 1/2" x 2 3/4"
(60 mm x 10 mm x 70 mm)



SR = Small Rectangle
(5 1/2" x 2 3/4")

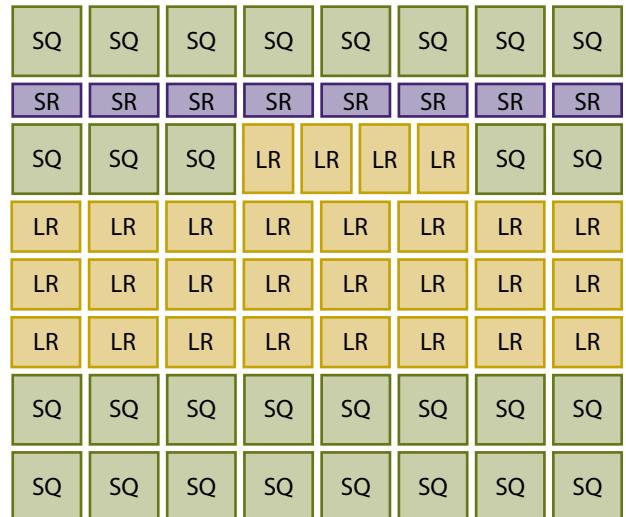

PRODUCT DATA: PAVERS

All metric dimensions are soft converted to Imperial. Dimensions and coverage include ½" (12.7 mm) joint. All weight per pallet includes a 50 lb pallet weight.

Old Dominion Circle Kits

	Depth	Radius	Diameter	Circumference	Area Of Circle	Pallet Wt
1 Pallet	2 ¾" (6 cm)	41 ¾" (106 cm)	83 ½" (212 cm)	262 ¾" or 21.86 ft (615.8 cm)	39.27 ft² (3.65 m²)	1,150 lb (522 kg)
2 Pallets	2 ¾" (6 cm)	58 ⅞" (148.4 cm)	116 ⅞" (296.8 cm)	367 ⅜" or 30.6 ft (932.7 cm)	78.54 ft² (7.29 m²)	1,150 lb (522 kg)

Holland Pavers

	Pieces / ft² (m²)	Pieces / Pallet	Coverage / Pallet	Weight / Piece	Weight / Pallet
Holland	4.63 pcs / ft² (50.04 pcs / m²)	486	104.88 ft² (9.74 m²)	6 lb (2.7 kg)	2,966 lb (1,346 kg)
Double Holland	2.31 pcs / ft² (24.86 pcs / m²)	216	93.46 ft² (8.68 m²)	12 lb (5.4 kg)	2,642 lb (1,199 kg)
Triple Holland	1.57 pcs / ft² (16.95 pcs / m²)	144	92 ft² (8.55 m²)	18 lb (8.16 kg)	2,650 lb (1,202 kg)

Plank Pavers

	Pieces / Pallet	Coverage / Piece	Coverage / Pallet	Weight / Piece	Weight / Pallet
Plank Paver Unit	396	4 pcs / ft² (43 pcs / m²)	99 ft² (9.2 m²)	7 lb (3.2 kg)	2,822 lb (1,280 kg)

Eco-Priora®

	Pieces / Pallet	Net Void / Ft²	Coverage / Piece	Coverage / Pallet	Weight / Unit	Weight / Pallet
4 x 8 Unit	432	13%	4.5 pcs / ft²	93.2 ft² (8.65 m²)	8 lbs (3.6 kg)	3,456 lb (1,567 kg)
8 x 8 Unit	192	9%	2.25 / ft²	83.04 ft² (7.71 m²)	16 lbs (7.2 kg)	3,172 lb (1,439 kg)

Uni-Ecoloc®

Must be purchased by the full layer or full pallet.

Coverage / Layer	Net Void / Ft²	Layers / Pallet	Coverage / Pallet	Weight / Layer	Weight / Pallet
11.35 ft² (1.055 m²)	12.8%	8	90.8 ft² (8.44 m²)	315 lb (143 kg)	3,360 lb (1,166 kg)

Uni-EcoStone®

Coverage	Net Void	Pieces / ft²	Pieces / Pallet	Coverage / Pallet	Weight / Piece	Weight / Pallet
3.52 pcs / ft² (37.9 pcs / m²)	12.18%	3.55	320	90.8 ft² (8.44 m²)	10 lb (4.5 kg)	3,250 lb (1,524 kg)

TurfStone

Coverage	Pieces / Pallet	Coverage / Pallet	Weight / Piece	Weight / Pallet
2.6 ft² / pc (0.24 pcs / m²)	35	91 ft² (8.45 m²)	65 lb (30 kg)	2,325 lb (1,055 kg)

Permeable Holland Herringbone

Pieces / ft²	Net Void	Pieces / Pallet	Coverage / Pallet	Weight / Piece	Weight / Pallet
4.75	8.4%	432	93.23 ft² (8.46 m²)	8 lb (3.6 kg)	3,456 lb (1,567 kg)

PRODUCT DATA: PATIO SLABS

All metric dimensions are soft converted to Imperial. Dimensions and coverage include 1/2" (12.7 mm) joint. All weight per pallet includes a 50 lb pallet weight.

Vancouver Bay Architectural Slabs

Product	Actual Size	Coverage / Unit	Coverage / Pallet	Pieces/Pallet	Weight / Unit	Weight / Pallet
Vancouver Bay 24 x 24	23 15/16" x 23 15/16" x 1 3/4" (608 mm x 606 mm x 45 mm)	4.0 ft ² (0.37 m ²)	112 ft ² (10.4 m ²)	24	90 lb (40.8 kg)	2,210 lb (1,002 kg)
Vancouver Bay 12 x 24	11 15/16" x 23 15/16" x 1 3/4" (304 mm x 608 mm x 45 mm)	2.0 ft ² (0.185 m ²)	112 ft ² (10.4 m ²)	56	45 lb (20.4 kg)	2,570 lb (1,166 kg)
Vancouver Bay 18 x 18	17 15/16" x 17 15/16" x 1 3/5" (454 mm x 454 mm x 41 mm)	2.25 ft ² (0.21 m ²)	126 ft ² (11.7 m ²)	56	45 lb (20.4 kg)	2,626 lb (1,191 kg)

Porcelain Architectural Slabs	Packaging		Weight Lbs		
	Dimensions	Per Case	Per Pallet	Each	Per SF
	23 5/8" x 23 5/8" x 3/4" (60 cm x 60 cm x 2cm)	2 pieces	60 pieces	36.4 lb each	9.4 lb per SF

Glacier Slate Architectural Slabs

Product	Actual Size	Coverage / Unit	Coverage / Pallet	Pieces/Pallet	Weight / Unit	Weight / Pallet
Glacier Slate 24 x 24	23 15/16" x 23 15/16" x 1 3/4" (608 mm x 606 mm x 45 mm)	4.0 ft ² (0.37 m ²)	112 ft ² (10.4 m ²)	24	90 lb (40.8 kg)	2,210 lb (1,002 kg)

Columbia Patio Series

Unit	Units / Pallet	Coverage	Coverage / Pallet	Weight / Piece	Weight / Pallet
8 x 16 Rectangle, Slate	168	1.125 pcs/ft ² (12.5 pcs/m ²)	149.33 ft ² (18.15 m ²)	18 lb (8.2 kg)	3,074 lb (1,394.3 kg)
8 x 16 Rectangle, Smooth	168	1.125 pcs/ft ² (12.5 pcs/m ²)	149.33 ft ² (18.15 m ²)	18 lb (8.2 kg)	3,074 lb (1,394.3 kg)
16 x 16 Square, Slate	84	.58 pcs/ft ² (6.25 pcs/m ²)	144.83 ft ² (13.44 m ²)	36 lb (16.4 kg)	3,074 lb (1,394.3 kg)
16 x 16 Square, Smooth	84	.58 pcs/ft ² (6.25 pcs/m ²)	144.83 ft ² (13.44 m ²)	36 lb (16.4 kg)	3,074 lb (1,394.3 kg)
16 x 24 Lrg. Rectangle, Slate	56	.39 pcs/ft ² (4.17 pcs/m ²)	143.6 ft ² (13.34 m ²)	60 lb (27.2 kg)	3,410 lb (1,546.75 kg)
16 x 24 Lrg. Rectangle, Smooth	56	.39 pcs/ft ² (4.17 pcs/m ²)	143.6 ft ² (13.34 m ²)	60 lb (27.2 kg)	3,410 lb (1,546.75 kg)

Slaton™

Coverage	Units / Pallet	Weight / Piece	Coverage /Pallet	Weight / Pallet
1.39 ft ² / pcs (0.42 m ² / pcs)	48	43 lb (19.5 kg)	66.7 ft ² (6.2 m ²)	2,114 lb (956 kg)

PAVER & SLAB PATTERNS

RUNNING BOND 1

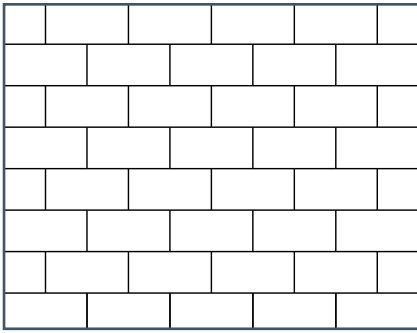

Clay Pavers
 Columbia Patio Series
 Eco-Priora 4 X 8
 Holland

RUNNING BOND 4

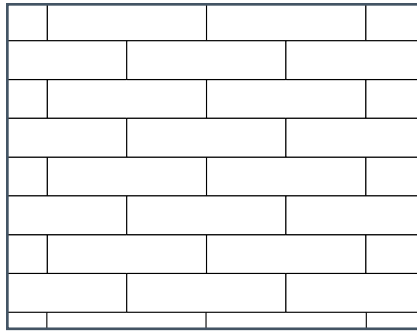

Plank Pavers

STACKED BOND 2

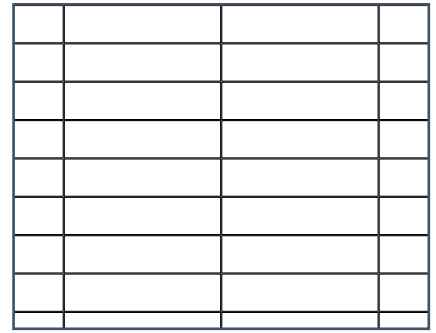

Plank Pavers

RUNNING BOND 2

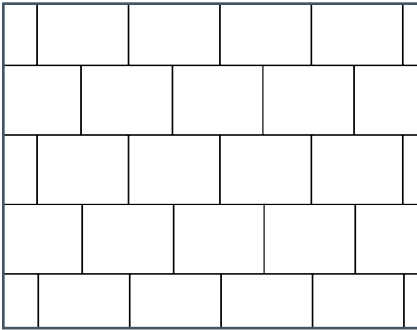

Roman Cobblestone Large
 Dominion Slate
 Dominion

1/3 RUNNING BOND

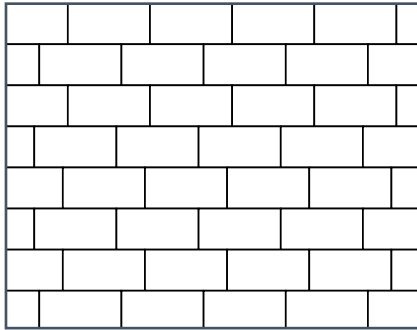

Clay Pavers
 Columbia Patio Series
 Eco-Priora 4 x 8
 Holland

HERRINGBONE-1

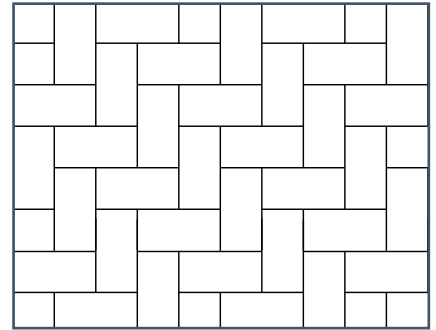

Clay Pavers
 Columbia Patio Series
 Eco-Priora 4 x 8
 Holland

RUNNING BOND 3

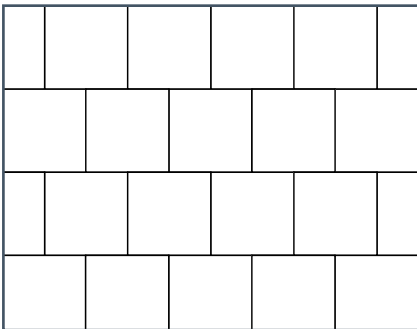

Dominion Slate Squares
 Eco-Priora Squares
 Architectural Slabs
 Columbia Patio Series
 Dominion Squares
 Holland
 Old Dominion Squares & Recs

STACKED BOND

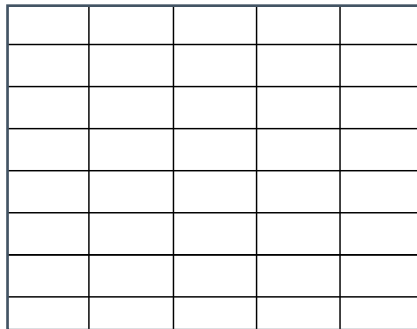

Clay Pavers
 Columbia Patio Series
 Eco-Priora 4 x 8
 Holland

HERRINGBONE-2

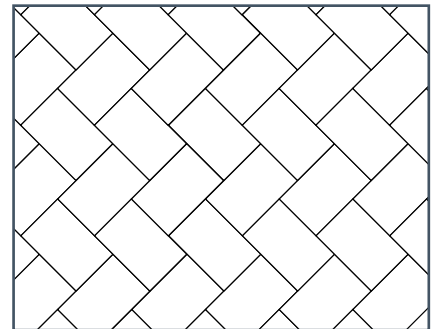

Roman Cobblestone Large
 Dominion Slate
 Dominion

PAVER & SLAB PATTERNS

HERRINGBONE 3

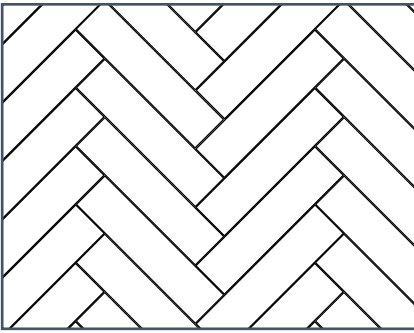

Plank Pavers

DOUBLE BASKETWEAVE

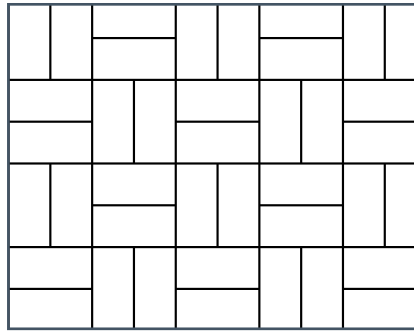

Clay Pavers
Columbia Patio Series
Eco-Priora 4 x 8
Holland

BOXED BASKETWEAVE-1

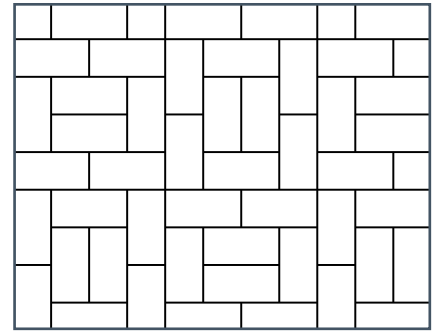

Clay Pavers
Columbia Patio Series
Eco-Priora 4 x 8
Holland

OFFSET 45° HERRINGBONE

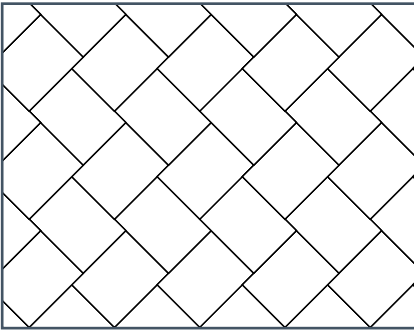

Roman Cobblestone

BASKETWEAVE

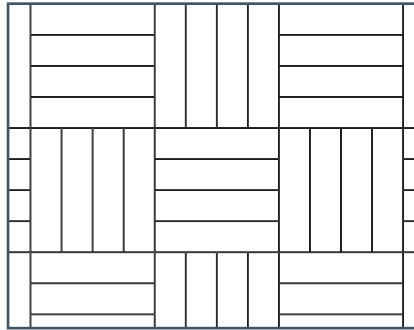

Plank Pavers

BOXED BASKETWEAVE-2

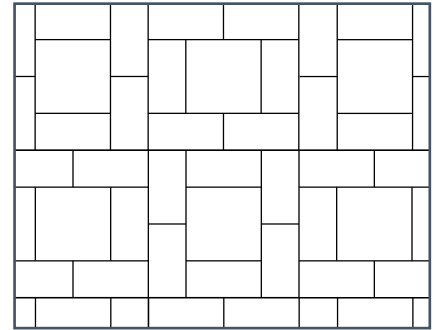

4 x 8: 75%, 8 x 8: 25%

Columbia Patio Series
Eco-Priora 4 x 8 + 8 x 8
Holland + Double Holland
Roman Cobblestone Sm. & Med.

SINGLE BASKETWEAVE

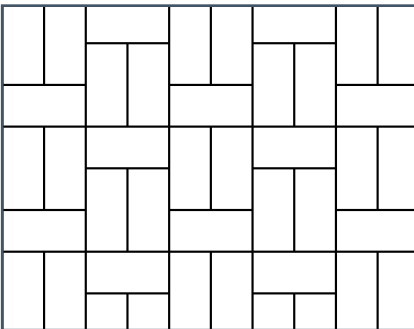

Clay Pavers
Columbia Patio Series
Eco-Priora 4 x 8
Holland

OFFSET BOXED BASKETWEAVE

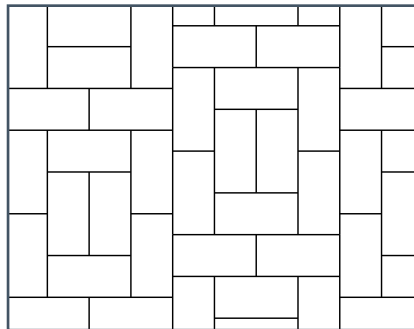

Clay Pavers
Columbia Patio Series
Eco-Priora 4 x 8
Holland

MUSTER-K

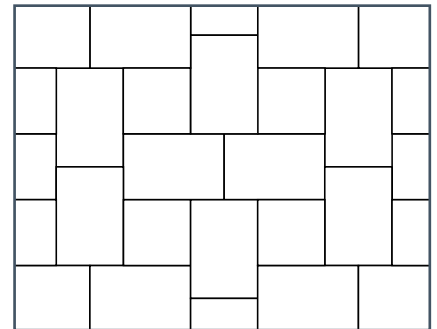

30% Squares, 70% Rectangles
Cobblestone
Columbia Patio Series
Dominion
Dominion Slate

MAGNUMSTONE®

MAXIMUM HEIGHT: 30 FEET



TERRACES



RETAINING WALLS



STORMWATER MANAGEMENT

Standard

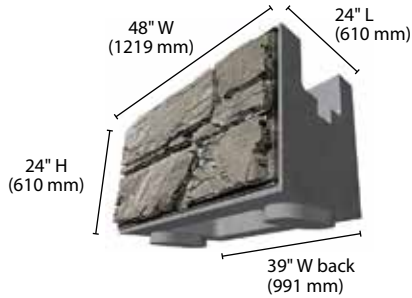

Standard Base

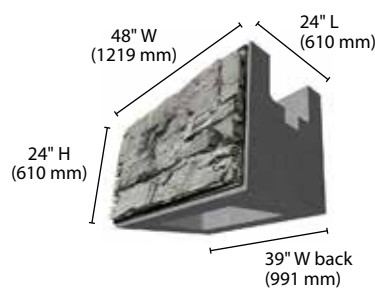

Standard Top

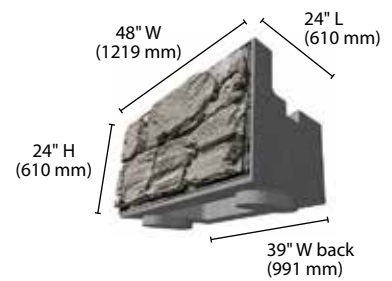

Half High

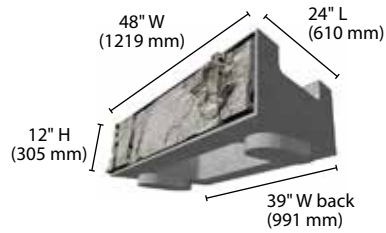

Half High Base

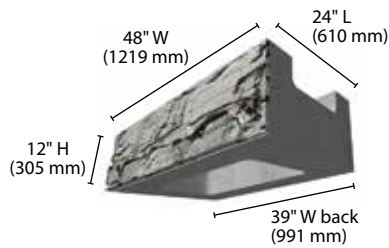

Half High Top

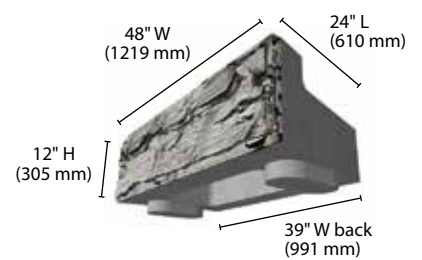

2 ft. Extender

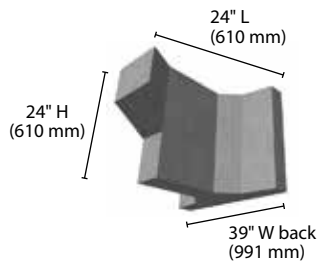

4 ft. Extender

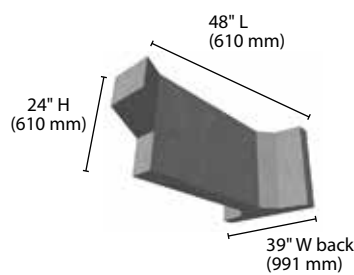

Corner End

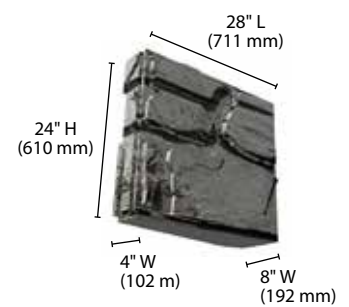

Half High Corner End

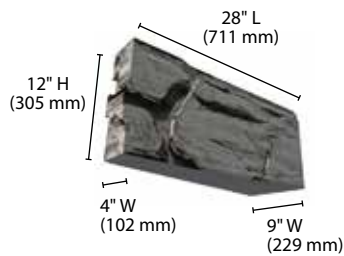

Step/Cap

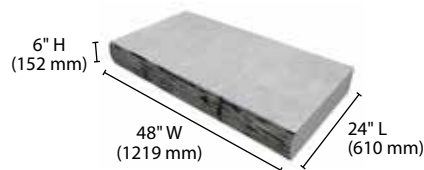

Dimensions and Weights may vary. Please check with local producer.

© CornerStone Wall Solutions, Inc. All Rights Reserved. More information can be found at magnumstone.com

MAGNUMSTONE®

MAXIMUM HEIGHT: 30 FEET



TERRACES



RETAINING
WALLS



STORMWATER
MANAGEMENT



Common Applications

GRAVITY WALLS

Gravity retaining walls can be built in tight areas with limited excavation space. MagnumStone's gravity retaining wall extenders offer designers the ability to build taller gravity retaining walls by increasing the wall depth in 2 ft. or 4 ft. increments. Gravity extenders deliver impactful performance while further fortifying retaining wall outside corners.

GEOGRID WALLS

Geogrid retaining wall designs are used to reinforce soil mass and help designers build retaining walls that will resist active forces from above and behind the wall. MagnumStone SecureLug connection offers a superior interlock between the specified grids and the block-to-block connection.

TERRACES WITH PLANTERS

Terraced planter retaining wall designs work in harmony with MagnumStone's big block retaining wall system. The lightweight, large units allow wall designers the flexible solutions with environmental benefits. The hollow core provides a plantable pocket to increase greenery and reduce the spread of heat island effect, commonly found in concrete surfaces.

WATER APPLICATIONS

MagnumStone's hollow core offers internal vertical and horizontal drainage design advantages. This minimizes the effects of hydrostatic pressures behind the wall. MagnumStone's wet-cast units provide durable 4,000 psi (27.5 MPa) concrete that's resistant to freeze-thaw cycles and saturated conditions. MagnumStone blocks are optimal for stormwater management solutions including dry ponds, retention ponds and drainage channels.

CORNERSTONE®

MAXIMUM HEIGHT: 30 FEET



TERRACES



RAISED GARDEN



RETAINING WALLS



STAIRS

R 50 Radius Cap Split Face

Tapered and Straight-Sided Units available.

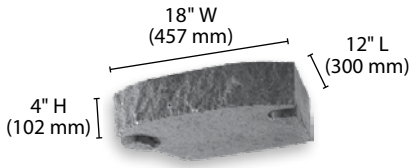

F 50 Cap Split Face

Tapered and Straight-Sided Units available.

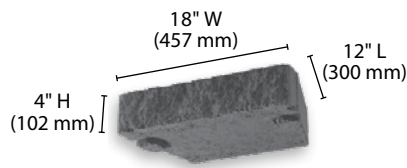

R 100 Radius Split Face

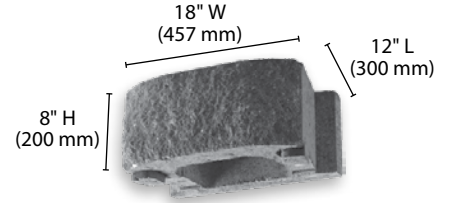

R 100 Cap Radius Split Face

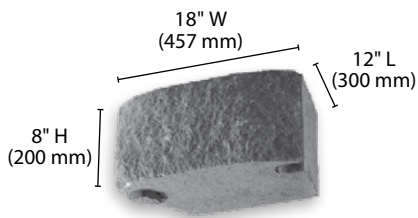

F 100 Corner Split Face

Available with Straight-Sides and Flat-Face only.

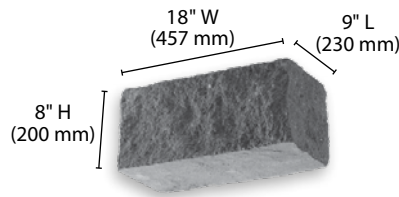

F 100 Split Face

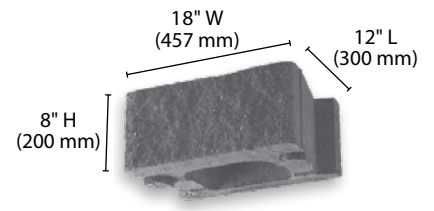

F 100 Cap Split Face

Tapered and Straight-Sided Units available.

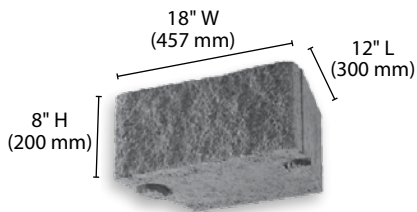

F 200 Split Face

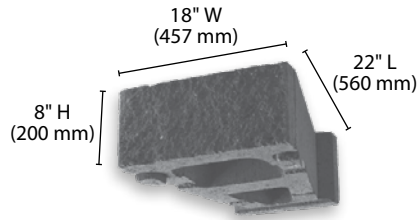

F 100 Near Vertical Split Face

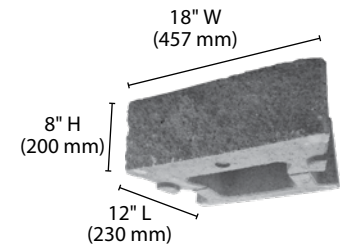

Gray



Summit Blend



CornerStone, Gray

MANORSTONE®

MAXIMUM HEIGHT: 3.5 FEET



TERRACES



RAISED GARDEN



RETAINING WALLS

Radius Split Face

Available in Gray, Northwest Blend and Summit Blend.



Flat Split Face

Available in Gray, Northwest Blend and Summit Blend.

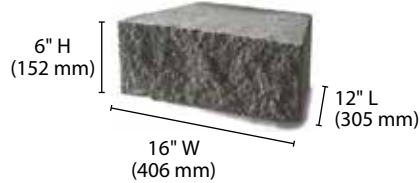

Straight Side Flat Split Face

Available in Gray, Northwest Blend and Summit Blend.



Corner Split Face

Available in Gray, Northwest Blend and Summit Blend.



Tapered Cap 3x18 Split Face

Available in Charcoal, Gray, Northwest Blend and Summit Blend.

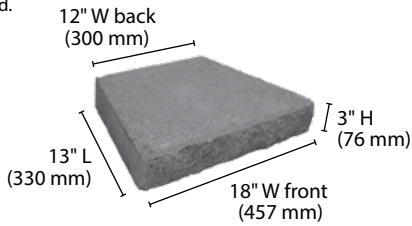

Cap 3x16 Smooth Face

Available in Gray and Onyx



Gray



Northwest Blend



Summit Blend



Cascade Blend



Charcoal



Onyx

Smooth Face Revers-a-Cap

Available in Cascade Blend and Onyx

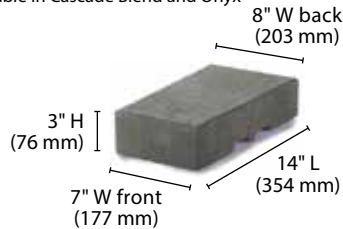

Coping Unit

Available in Cascade Blend, Gray and Onyx



ManorStone, Summit Blend

MANORSTONE® ELITE

MAXIMUM HEIGHT: 3.5 FEET



TERRACES



RAISED GARDEN



RETAINING WALLS

Tapered Sides Smooth Face

Available in Charcoal and Gray



Tapered Sides Split Face

Available in Gray

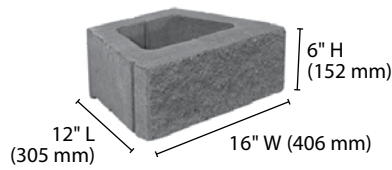

Tapered Cap 3x18 Split

Available in Charcoal and Gray

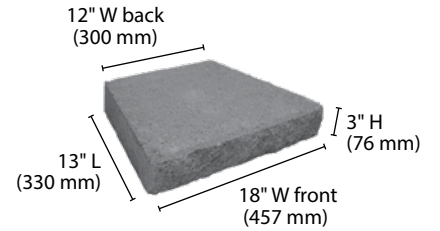

Cap 3x16 Smooth Face

Available in Gray and Onyx



Coping Unit

Available in Cascade Blend and Onyx



Smooth Texture (Shown in Charcoal)



Split Face Texture (Shown in Gray)



Onyx



Smooth Face in Charcoal with Onyx Caps

CYPRESSSTONE™

MAXIMUM HEIGHT: 4 FEET



TERRACES



RAISED GARDEN



RETAINING WALLS

Tapered Unit



Corner Unit

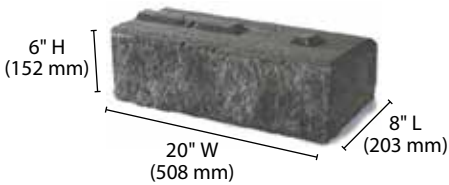

Revers-a-Cap

Available in Cascade Blend, Charcoal and Onyx.

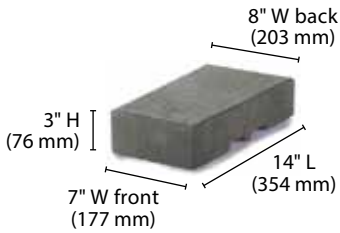

Coping Unit

Available in Cascade Blend and Onyx.



Cascade Blend



Summit Blend

ROMAN CYPRESS™

MAXIMUM HEIGHT: 4 FEET



RAISED GARDEN



RETAINING WALLS



STAIRS

Tapered Unit



Corner Unit

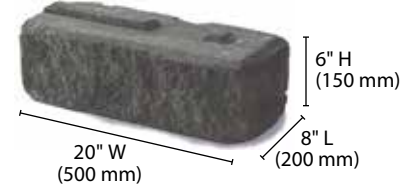

Revers-a-Cap

Available in Cascade Blend and Onyx.

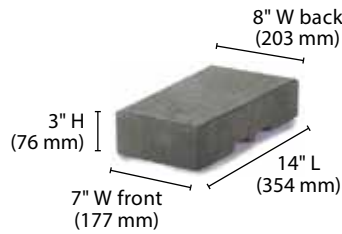

12" Coping Unit

Available in Cascade Blend and Onyx.

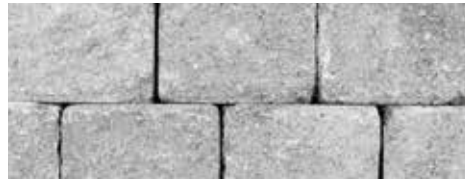

Cascade Blend



Summit Blend

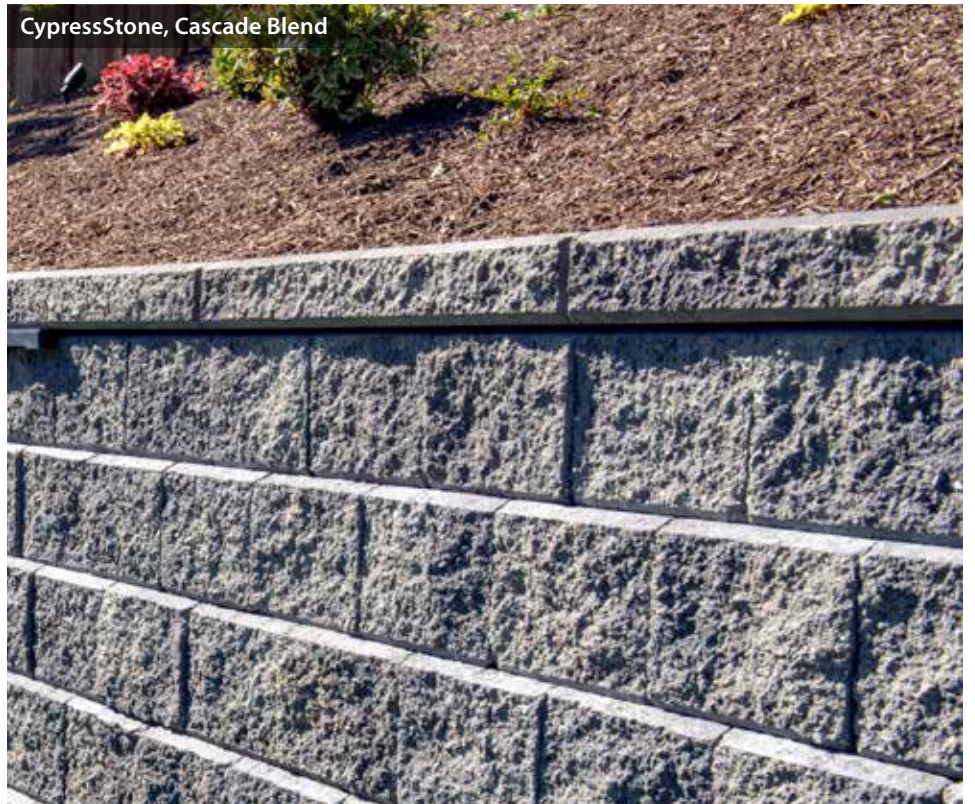

STACKSTONE®

MAXIMUM HEIGHT: 2 FEET



FIRE PITS



RAISED GARDEN



RETAINING WALLS

4 x 8 Cap

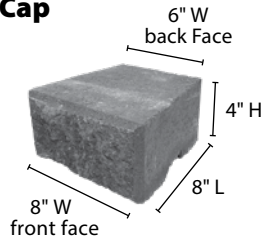

4 x 12 Cap

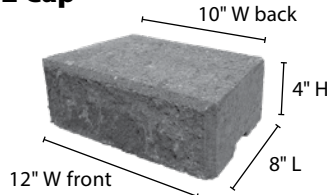

4 x 8 Unit

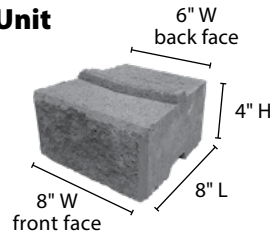

4 x 12 Unit

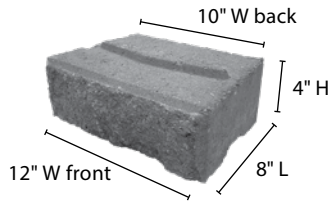

9" Coping Unit

Available in Onyx.



Jumbo Unit

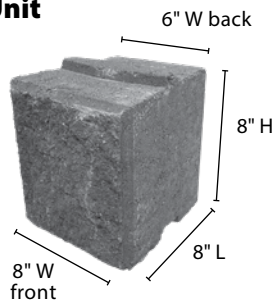

90° Corner Unit

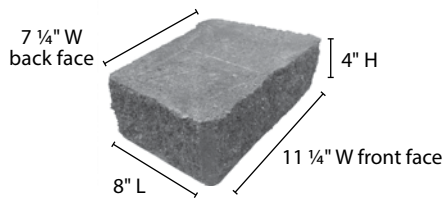

TUSCANSTONE™

MAXIMUM HEIGHT: 2 FEET



BENCHES



FIRE PITS



PATIOS



WATER FEATURE

12" Unit

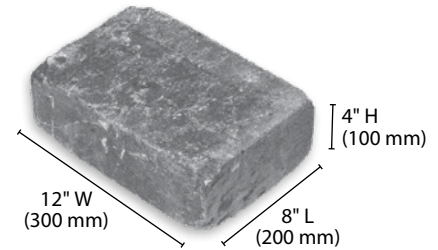

Charcoal



Summit Blend



Cascade Blend



Northwest Blend



Summit Blend



StackStone, Summit Blend

PRODUCT DATA: RETAINING WALLS

All metric dimensions are soft converted to Imperial. Dimensions and coverage include 1/2" (12.7 mm) joint. All weight per pallet includes a 50 lb pallet weight.

MagnumStone™

	Coverage	Units / Pallet	Coverage / Pallet	Weight / Piece	Weight / Pallet
Standard	8 ft ² /pc	2	16 ft ²	1370 lb (621 kg)	2800 lb (1270 kg)
Standard Base	8 ft ² /pc	2	16 ft ²	1345 lb (610 kg)	2750 lb (1247 kg)
Standard Top	8 ft ² /pc	2	16 ft ²	1220 lb (553 kg)	2500 lb (1134 kg)
Half High	4 ft ² /pc	2	8 ft ²	750 lb (340 kg)	1560 lb (708 kg)
Half High Base	4 ft ² /pc	2	8 ft ²	725 lb (328 kg)	1510 lb (685 kg)
Half High Top	4 ft ² /pc	2	8 ft ²	680 lb (308 kg)	1420 lb (644 kg)
2 Ft Extender	n/a	2	n/a	520 lb (236 kg)	1100 lb (499 kg)
4 Ft Extender	n/a	2	n/a	820 lb (372 kg)	1700 lb (771 kg)
Corner End	4.66 ft ² /pc	2	9.32 ft ²	340 lb (154 kg)	740 lb (336 kg)
Half High Corner End	2.33 ft ² /pc	4	4.66 ft ²	170 lb (77 kg)	740 lb (336 kg)
Step/Cap	2 ft ² /pc	3	6 ft ²	290 lb (131 kg)	930 lb (422 kg)

CornerStone® 50 (Maximum gravity wall height: 3')

	Coverage	Units / Pallet	Coverage / Pallet	Weight / Piece	Weight / Pallet
R 50 Cap Tapered	1.5 ln ft/pc (0.457 ln m / pc)	48	72 ln ft (21.95 ln m)	60 lb (27 kg)	2,930 lb (1,329 kg)
R 50 Cap Straight Sides	1.5 ln ft/pc (0.457 ln m / pc)	48	72 ln ft (21.95 ln m)	60 lb (27 kg)	2,930 lb (1,329 kg)
F 50 Cap Tapered	1.5 ln ft/pc (0.457 ln m / pc)	48	72 ln ft (21.95 ln m)	60 lb (27 kg)	2,930 lb (1,329 kg)
F 50 Cap Straight Sides	1.5 ln ft/pc (0.457 ln m / pc)	48	72 ln ft (21.95 ln m)	60 lb (27 kg)	2,930 lb (1,329 kg)

Note: Each course batters back 5/8" from the previous course.

CornerStone® 100 (Maximum gravity wall height: 4'. Without any surcharges. Maximum reinforced wall height: 30'. Minimum radius 3' 5")

	Coverage	Units / Pallet	Coverage / Pallet	Weight / Piece	Weight / Pallet
R 100 Unit	1 pc/ft ² (10.76 pc/m ²)	40	40 ft ² (3.72 m ²)	76 lb (34.5 kg)	3,090 lb (1,402 kg)
R 100 Cap	1.5 ln ft/pc (0.457 ln m/pc)	32	48 ln ft (14.63 ln m)	110 lb (50 kg)	3,570 lb (1,690.3 kg)
R 100 Cap Straight Sides	1.5 ln ft/pc (0.457 ln m/pc)	24	34.56 ln ft (10.54 ln m)	122.62 lb (56 kg)	3,000 lb (1,360.8 kg)
F 100 Unit	1 pc/ft ² (10.76 pc/m ²)	40	40 ft ² (3.72 m ²)	83 lb (34 kg)	3,570 lb (1,690.3 kg)
F 100 Cap	1.5 ln ft/pc (0.457 ln m/pc)	32	48 ln ft (14.63 ln m)	110 lb (50 kg)	3,570 lb (1,690.3 kg)
F 100 Cap Straight Sides	1.5 ln ft/pc (0.457 ln m/pc)	24	48 ln ft (14.63 ln m)	122.62 lb (50 kg)	3,000 lb (1,360.8 kg)
F-100 Corner	1.5 ft ² /pc (.093 m ² /pc)	40	60 ft ² (3.72 m ²)	85 lb (38.5 kg)	3,450 lb (1,565 kg)

Note: Each course batters back 5/8" from the previous course.

CornerStone® 200

	Coverage	Units / Pallet	Coverage / Pallet	Weight / Piece	Weight / Pallet
R 200 Unit	1 pc / ft ² (10.76 pc/m ²)	25	25 ft ² (2.325 m ²)	130 lb (59 kg)	3,330 lb (1,510 kg)
F 200 Unit	1 pc / ft ² (10.76 pc/m ²)	25	25 ft ² (2.325 m ²)	130 lb (59 kg)	3,330 lb (1,510 kg)

PRODUCT DATA: RETAINING WALLS

All metric dimensions are soft converted to Imperial. Dimensions and coverage include 1/2" (12.7 mm) joint. All weight per pallet includes a 50 lb pallet weight.

ManorStone® (Maximum wall height: 3'. Minimum radius: 2' 8")

	Coverage	Units / Pallet	Coverage / Pallet	Weight / Piece	Weight / Pallet
Split Face Radius Tapered Sides	1.5 pcs / ft ² (16.2 pcs / m ²)	45	30 ft ² (2.79 m ²)	65.5 lb (29.7 kg)	2997.5 lb (1,360 kg)
Split Face Tapered Sides	1.5 pcs / ft ² (16.2 pcs / m ²)	45	30 ft ² (2.79 m ²)	64 lb (29 kg)	2,930 lb (1,329 kg)
Split Face Straight Sides	1.5 pcs / ft ² (16.2 pcs / m ²)	45	30 ft ² (2.79 m ²)	79 lb (36 kg)	3,605 lb (1,636 kg)
Split Face Corner Unit	1 pc / ft ²	60	60 ft ²	56 lb (25.5 kg)	3,410 lb (1,547 kg)
Split Face Tapered Cap Unit	0.8 pcs / ln ft	72	90 ln ft	45 lb (20.4 kg)	3,290 lb (1,493 kg)
Smooth Face Cap Unit	.75 pcs / ln ft	72	96 ln ft	43 lb (19.5 kg)	3,146 lb (1,427 kg)
Smooth Face Revers-a-Cap	1.5 pcs / ln ft	96	64 ln ft	22 lb (10 kg)	2162 lb (980 kg)
Coping Unit	0.5 pcs / ln ft	36	72 ln ft	62 lb (28 kg)	2262 lb (1,026 kg)

ManorStone® Elite

	Coverage	Units / Pallet	Coverage / Pallet	Weight / Piece	Weight / Pallet
Smooth Face Tapered Sides	1.5 pcs / ft ² (16.2 pcs / m ²)	54	36 ft ² (3.34 m ²)	46 lb (21 kg)	2,484 lb (1,126.7 kg)
Split Face Tapered Sides	1.5 pcs / ft ² (16.2 pcs / m ²)	54	36 ft ² (3.34 m ²)	46 lb (21 kg)	2,484 lb (1,126.7 kg)
Split Face Tapered Cap Unit	0.8 pcs/ln ft	72	90 ln ft	45 lb (20.4 kg)	3,290 lb (1,493 kg)
Smooth Face Cap Unit	.75 pcs/ln ft	72	96 ln ft	43 lb (19.5 kg)	3,146 lb (1427 kg)
Coping Unit	0.5 pcs / ln ft	36	72 ln ft (19.5 ln m)	62 lb (30.8 kg)	2,262 lb (1,010 kg)

CypressStone™ and Roman Cypress™

(Maximum gravity wall height: 4'. Minimum radius: 8'. Please consult a sales representative for maximum reinforced wall height.)

	Coverage	Units / Pallet	Coverage / Pallet	Weight / Piece	Weight / Pallet
Tapered Unit	3 pcs / ft ² (32.3 pcs / m ²)	72	24 ft ² (1.85 m ²)	45 lb (20.41 kg)	3,240 lb (2,630 lb)
Corner Unit	1.2 ft ² / pc (0.077 m ² / pc)	30	36 ft ² (2.32 m ²)	77 lb (35 kg)	2,360 lb (1,070 kg)
Revers-a-Cap [^]	1.5 pcs / ln ft (4.92 pcs / ln m)	96	64 ln ft (22.9 ln m)	22 lb (10 kg)	2,640 lb (1,220 kg)
9" Coping Unit	2 ln ft / pc (0.6 ln m / pc)	36	72 ln ft (19.5 ln m)	52 lb (23.64 kg)	1,922 lb (873 kg)
12" Coping Unit	2 ln ft / pc (0.6 ln m / pc)	36	72 ln ft (19.5 ln m)	62 lb (30.8 kg)	2,262 lb (1,010 kg)

[^] Coverage is for 8" faces only. If alternating 7" and 8" faces, there are 1.6 pcs / ln ft (5.25 pcs / ln. m). Coverage per pallet is 60 ln ft (18.29 ln m).

PRODUCT DATA: RETAINING WALLS

All metric dimensions are soft converted to Imperial. Dimensions and coverage include 1/2" (12.7 mm) joint. All weight per pallet includes a 50 lb pallet weight.

StackStone® (Maximum wall height: 2'. Minimum radius: 2' 4")

	Coverage	Units / Pallet	Coverage [±] / Pallet	Weight / Piece	Weight / Pallet
4 x 8 Wall Unit	4.5 pcs / ft ² (48.44 pcs / m ²)	168	37.33 ft ² (3.47 m ²)	18 lb (8.6 kg)	3,242 lb (1,470 kg)
4 x 8 Cap Unit	1.6 pcs / ln ft (4.92 pcs / ln m)	168	122 ln ft (34.14 ln m)	18 lb (8.6 kg)	3,242 lb (1,470 kg)
4 x 12 Unit	3 pc / ft ² (32.3 pc / m ²)	126	42 ft ² (3.9 m ²)	26 lb / pc (11.8 kg / pc)	3,276 lb (1,487 kg)
4 x 12 Cap Unit	1 pc / ln ft (32.28 pc / ln m)	126	126 ln ft (38.4 ln m)	26 lb / pc (11.8 kg / pc)	3,276 lb (1,487 kg)
8 x 8 Jumbo Unit	2.25 pc / ft ² (24.22 pc / m ²)	96	42.67 ft ² (3.96 m ²)	32 lb / pc (14.5 kg / pc)	3,072 lb (1,392 kg)

	Coverage [±] / Pallet	Units / Pallet	Weight / Piece	Weight / Pallet
90° Corner Unit	44 ft ² (4.08 m ²)	144	24 lb / pc (10.89 kg / pc)	3,456 lb (1,567.6 kg)

For walls built by alternating 6" and 8" faces, there are 54.9 pcs / m² (5.1 pc / ft²) and 3.06 m² (32.94 ft²) per pallet.

For walls built by alternating 6" and 8" faces, there are 5.6 pc / ln m (1.7 pc / ln ft) and 30.11 ln m (98.8 ln ft) per pallet.

TuscanStone™

	Coverage	Units / Pallet	Coverage / Pallet	Weight / Piece	Weight / Pallet
12" Unit	3 pcs / ft ² (32.15 pcs m ²)	90	30 ft ² (2.80 m ²) Using 4" x 12" face	30 lb (14 kg)	2,750 lb (1,247.3 kg)



ManorStone

STOCK FACE BRICK COLOR SELECTIONS

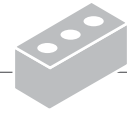

Whites & Grays



Redondo Gray - Mission ■



Redondo Gray - Smooth ■

Reds & Blacks

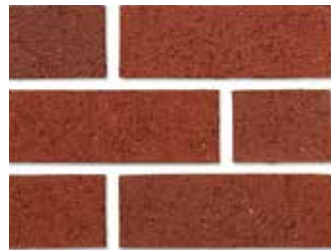

Inca - Mission ■



Inca - Smooth ■



Mountain Blend - Mission ●



Forest Blend - Mission ●



Clinker ●



Coal Creek ●



Midnight Sky ■

Textured Reds



Mutual Used ●



Sheffield ●



Old University ■



Pacific Handmold ●



Classic Used ■



Windsor ●



Covington ●

STOCK FACE BRICK COLOR SELECTIONS

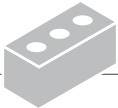

Neutrals



Harbor Mist ■



Westport Used ■



Ashland ●



Chateau Gray ■



Canyon Mist ■



Cascade Spice ●

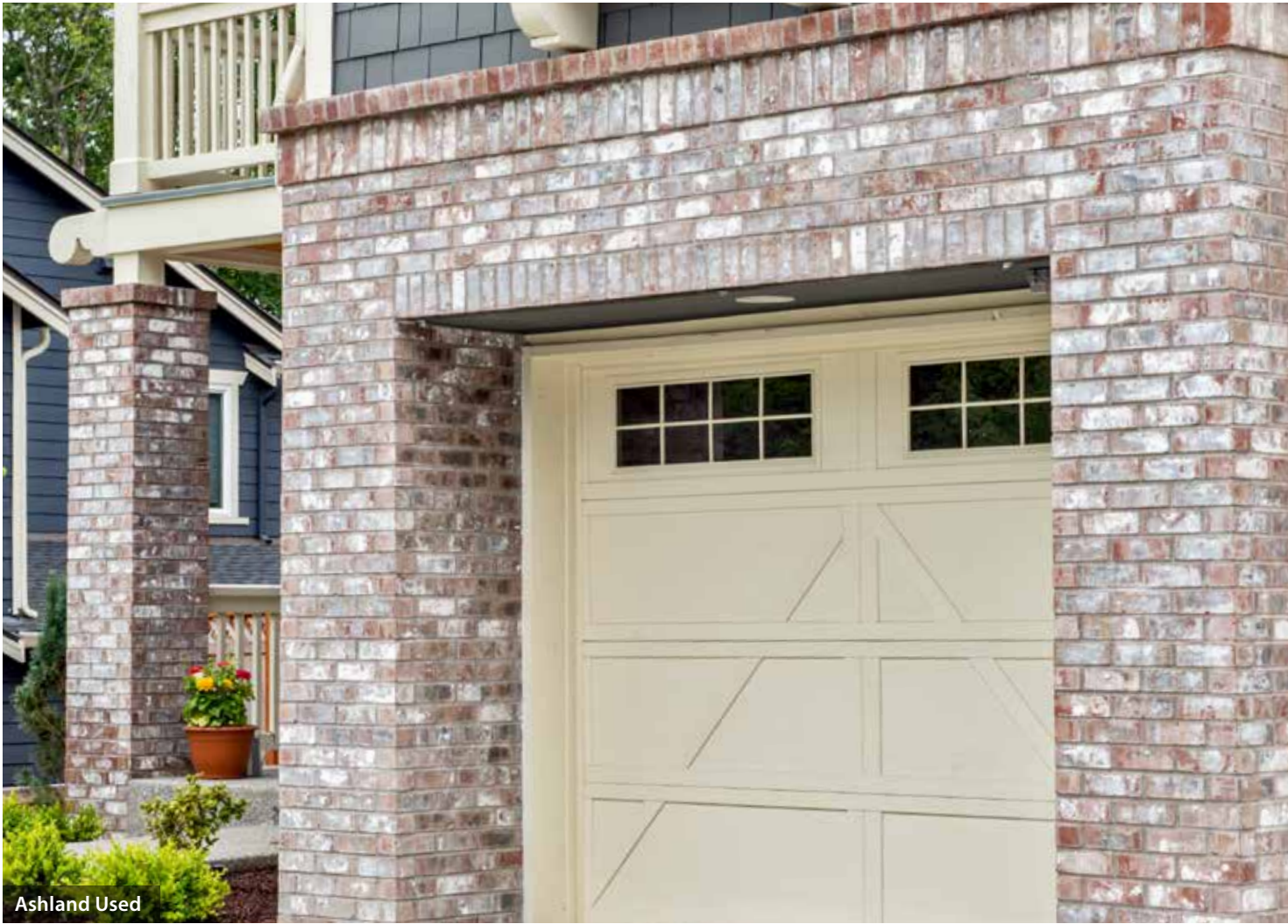

Ashland Used

Plant key: ● = Columbia Plant ■ = Mica Plant

SLIMBRICK® COLOR SELECTIONS

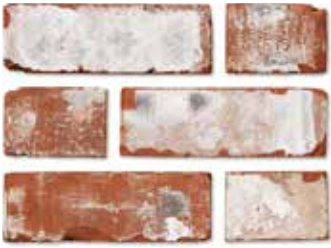

Ashland Used ●



Canyon Mist ■



Chateau Gray ■



Classic Used ■



Coal Creek ●



Coffee House ●



Covington ●

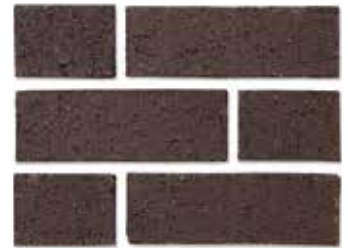

Ebony ■



Forest Blend ●

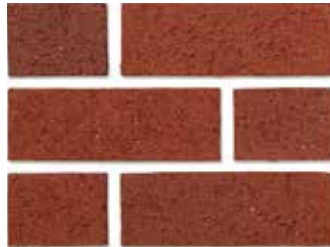

Inca ■



Midnight Sky ■



Mutual Used ●



Ashland Used



Old University ■



Westport Used ■

SLIMBRICK® GLAZED COLOR SELECTIONS



Gloss Glaze



Onyx ■



Parchment ■



Picket Fence ■

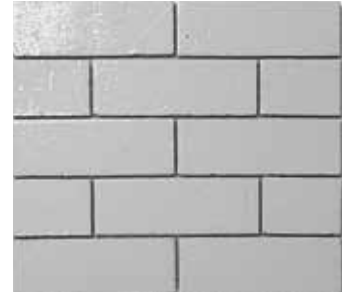

Smoke ■

Matte Glaze

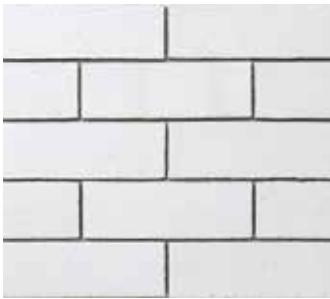

Powder ■



Slimbrick® Picket Fence

Cobblefield®



Echo Ridge®



San Francisco

Dressed Fieldstone



Bucks County



Echo Ridge®

Country Ledgestone



Ashfall



Aspen



Black Rundle



Bucks County



Chardonnay



Echo Ridge®



Gunnison™



Skyline



Wheaton™



Wolf Creek®



Country Ledgestone



Pro-Fit® Ledgestone



Platinum

Pro-Fit® Terrain Ledgestone



Ethos



Trek

Pro-Fit® Alpine Ledgestone



Black Mountain



Black Rundle



Chardonnay



Dark Ridge™



Echo Ridge®



Pheasant



Winterhaven™

Pro-Fit® Modera Ledgestone



Carbon



Pro-Fit® Alpine Ledgestone, Echo Ridge®

CULTURED STONE



Handmade Brick



Canvas™

River Rock



Lake Tahoe

Stream Stone



Spring

Sculpted Ashlar



Echo Ridge®



Grouse



Silver Shore

Southern Ledgestone



Bucks County



Echo Ridge®

Tenley Brick™



Kullen™



Loften™



Nori™



Wildon™



Tenley Brick, Wildon



Cliffstone®



Banff Springs



Boardwalk



Montecito®



Whitebark®

European Ledge®



Sea Cliff®



Beach Pebble



Birch



Whitecap®

Loreio™



Farola™



Hollin™



Lilia™



Talavera™

RoughCut®



Casa Blanca



Loire Valley™

Limestone



Moonlight



Grand Banks™



Loreio, Farola



Stacked Stone



Chapel Hill®



Dark Rundle®



Nantucket



Silver Lining



Black River



Koryak Ridge

TundraBrick®



Ashland



Chalk Dust



Ironside



Stacked Stone, Koryak Ridge



Roughcut®, Loire Valley™



Bitterroot LedgeStone



Kettle Valley LedgeStone



Canyon Creek & Glacier Mountain Blend

NATURAL STONE THIN VENEER SELECTIONS

Mutual Materials offers a wide variety of Natural Stone. These images are representative of offerings, but may not be complete. If you are seeking Natural Stone, give us a call or stop in to a branch so that we can help you find the ideal stone for your project.



Alpine Ledgestone Black Horse



Alpine Ledgestone Wolf Creek



Bitterroot Ledgestone



Black Horse Ledgestone



Cabinet Gorge Ledgestone



Cabinet Ridge Ledgestone



Camas Thin Veneer Squares & Recs



Canyon Creek



Canyon Creek

NATURAL STONE THIN VENEER SELECTIONS



Mutual Materials offers a wide variety of Natural Stone. These images are representative of offerings, but may not be complete. If you are seeking Natural Stone, give us a call or stop in to a branch so that we can help you find the ideal stone for your project.



Choctaw Dark Squares & Recs



Glacier Mountain



**Rmq E-Z Set Thin Veneer
Heritage Ledge Stone &
Jumper Blend Sunset Silver**



Ibex Ledge Stone



Kettle Valley Ledge Stone



Moss Rock Squared
Stocking in Bend only.



**Rocky Mountain Granite
Ledge Stone**



Rocky Mountain Moss



Tundra Cream Rubble



Western Drystack Ledge Stone



White Mountain



Glacier Mountain

NATURAL STONE SELECTIONS

Mutual Materials offers a wide variety of Natural Stone. These images are representative of offerings, but may not be complete. If you are seeking Natural Stone, give us a call or stop in to a branch so that we can help you find the ideal stone for your project.

Flagstones



Bluestone: Pennsylvania Variegated Pre-Cut Stone



Cabinet Ridge



Frontier Select Flagstone



Mica Slate Birch Creek
Thickness available in 3/4", .75" and 1.25"



Mica Slate Charcoal
Thickness available in 3/4", .75" and 1.25"



Mica Slate Lone Pine Gold



Variegated Flagstone



Sage Hill Stepstone
Stocking in Missoula only.



Montana Bronze

Montana Bronze has a high iron content and will continue to bleed rust in wet climates. Sealing the stone will help but not prevent it.



Natural Stone

EDWARD'S STONE - NATURAL STONE

Mutual Materials offers a wide variety of Natural Stone. These images are representative of offerings, but may not be complete. If you are seeking Natural Stone, give us a call or stop in to a branch so that we can help you find the ideal stone for your project.

Ashlar



Flint Hills



Moose's Tooth Tumbled



Sunset Tumbled

Multi 123



Southern Cream

Multi 468



Iron Mill



Skyline Grey



Southern Cream

Razorledge



Fond du Lac

Stack 468



Skyline Grey



Razorledge, Fond du Lac

MUTUAL MATERIALS BRANCH LOCATIONS

For product information and customer service call **1-888-MUTUALØ** (688-8250)

EASTERN WASHINGTON

Spokane*

6721 E Trent Ave
Spokane, WA 99212
Phone: (509) 922-4100

WESTERN WASHINGTON

Auburn

1357 W. Valley Hwy N
Auburn, WA 98002
Phone: (253) 939-7854

Bellevue*

605 - 119th Ave NE
Bellevue, WA 98005
Phone: (425) 452-2363

Bellingham

4050 Bakerview Spur
Bellingham, WA 98226
Phone: (360) 676-2880

Marysville

1410 Grove Street
Marysville, WA 98270
Phone: (425) 353-9686

Olympia*

3150 29th Ave SW
Tumwater, WA 98512
Phone: (360) 357-3343

Port Orchard*

1515 Vivian Court
Port Orchard, WA 98366
Phone: (360) 876-1845

Seattle

4302 S 104th Place
Tukwila, WA 98178
Phone: (425) 452-2400

Tacoma (Parkland)

2201 112th Street S
Tacoma, WA 98444
Phone: (253) 238-5490

Woodinville

8523 216th St SE
Woodinville WA 98072
Phone: (425) 818-8556

OREGON & SOUTHWEST WASHINGTON

Bend*

631 SE Woodland Blvd
Bend, OR 97702
Phone: (541) 312-3623

Clackamas

15791 SE Piazza Ave
Clackamas, OR 97015
Phone: (503) 655-7167

Durham

18230 SW Boones Ferry Rd.
Durham, OR 97224
Phone: (503) 624-8860

Portland Showroom

2175 NW Raleigh Street
Suite 103
Portland, OR 97210
Phone: (503) 595-0855

Salem

2245 Judson Street SE
Salem, OR 97302
Phone: (503) 375-6050

Vancouver*

10019 NE 72nd Ave
Vancouver, WA 98686
Phone: (360) 573-5925

IDAHO

Boise

7455 S Federal Way
Boise, ID 83716
Phone: (208) 345-1584

Hayden*

30 W. Orchard Ave
Hayden, ID 83835
Phone: (208) 762-3230

MONTANA

Missoula*

2910 American Way
Missoula, MT 59808
Phone: (406) 549-2011

CANADA SALES

Phone: (604) 888-0555



At Mutual Materials, our purpose is to help our customers **Build Beauty That Lasts.**

We help our customers build better, more inviting spaces by providing appealing hardscape and masonry products that stand the test of time.

Start Building Your Beauty Today.



Let's Connect!

www.MutualMaterials.com



Uni Eco-Priora is a registered trademark of Uni-Group USA. CornerStone is a registered trademark of CornerStone Wall Solutions, Inc. Slaton is a trademark of Anchor Wall Block Systems, Inc. All other trademarks used herein are property of Mutual Materials Co.

©2024 Mutual Materials



*These branches have a Natural Stone yard.